

Article number: 2310309451ESD

Description: E+G Antistatic base for levelling elements
LV.A-100-14-AS-M8x43-ESD-C

Measures

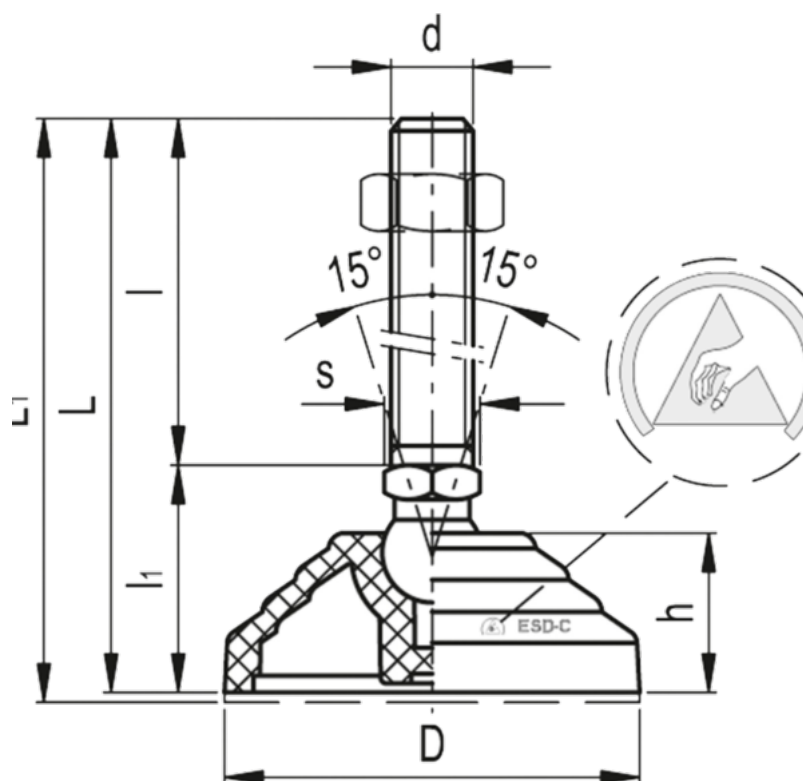

Articulation = 14	Max load = 18000
D = 100	s = 14
d = M8	Weight in (g) = 146
h = 24	
l = 43	
L1 = 33	
L = 76	
L1 = 79	